

# BULLETIN

DE LA SOCIÉTÉ DES SCIENCES ET DES LETTRES DE ŁÓDŹ

2018

Vol. LXVIII

---

Recherches sur les déformations

no. 2

---

pp. 109–122

*Dedicated to the memory of  
Professor Yurii B. Zelinskii*

*Osamu Suzuki, Julian Ławrynowicz, Małgorzata Nowak-Kępczyk,  
and Mariusz Zubert*

## **SOME GEOMETRICAL ASPECTS OF BINARY, TERNARY, QUATERNARY, QUINARY AND SENARY STRUCTURES IN PHYSICS**

### **Summary**

It is observed that quinary and senary structures like in pentacene and several other polymers may be composed from binary and ternary structures in the sense of differential-equational and geometrical description. In the case of pentacene its leaves are attached to the silicon background and have the form of five connected carbon-hydrogen hexagons; in total they do not form the precisely planar structure but a slightly wavy structure which minimizes total energy. In the case of a quinary structure the leaves form solitary, nearly periodical zigzags and meanders.

*Keywords and phrases:* finite-dimensional algebras, associative rings and algebras, binary physical structure, ternary physical structure, quinary physical structure, senary physical structure, pentacene, polymer

### **Contents and introduction**

1. Quinary and senary structures in pentacene and several other polymers
2. The role of total energy maxima for the infrared and Raman activity energy spectra
3. Decomposition of a quinary structure to binary structures
4. Decomposition of a senary structure to ternary structures

5. Slightly wavy behaviour of the system of hexagons in a pentacene leaf
6. Zigzag or meander soliton behaviour of a twisted structure of pentagons in a pentacene leaf. The sine-like case
7. An analogue of a pentacene structure in the cosine-like case
8. Pentacene as a foliated manifold with a soliton behaviour of leaves

This paper in some sense is a continuation of the paper [3] by E. Z. Frątczak, J. Ławrynowicz, M. Nowak-Kępczyk, H. Polatoglou, L. Wojtczak and [7] by J. Ławrynowicz, M. Nowak-Kępczyk, and O. Suzuki.

## 1. Quinary and senary structures in pentacene and several other polymers

When looking at formulae for chromophore P in the elongated form (A, B) and the cyclic form (C, D): A,C – Pr, B,D–Pfr, where Pr and Pfr are red-absorbing (infra-red-absorbing) forms of phytochrome, respectively (Fig. 1, cf. [1, 2, 6, 10]) we can see a quinary structure together with a senary structure.

In the case of pentacene in the usual form  $C_{22}H_{14}$  (Fig. 2) where C stands for the carbon atom, H for hydrogen atom, a thin film of pentacene forms almost co-planar leaves consisting of five pentagons with each pair having one side of the vertices of hexagons in common, attached as the whole structure to the silicone  $SiO_2$  substrate. An example of a quinary structure in principle possible for pentacene is shown in Fig. 3. There are two basic forms of position of pentacene leaves with respect to substrate, as shown in the figure.

## 2. The role of total energy maxima for the infrared and Raman activity energy spectra

When changing the wave number we meet two sharp energy maxima (Fig. 4) which may serve for the corresponding nanomolecule as the nanomotor where the original energy structure is changed to a quinary structure (cf. J. -P. Sauvage, Sir J. Fraser Stoddart, and B. L. Feringa [11]), more precisely, for a structure of leaves corresponding to Fig. 3.

Looking more carefully, when changing the wave number in both infrared and Raman activity energy spectra (Figs 5 and 6) we meet again two sharp maxima which may serve for the corresponding nanomolecule as nanomotors where the original senary structure has changed into a quinary structure according to the formulae [3]:

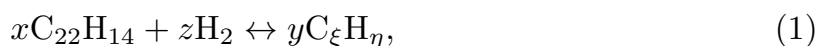

where  $x, y, \xi, \eta$  are positive integers and  $z$  is an integer.

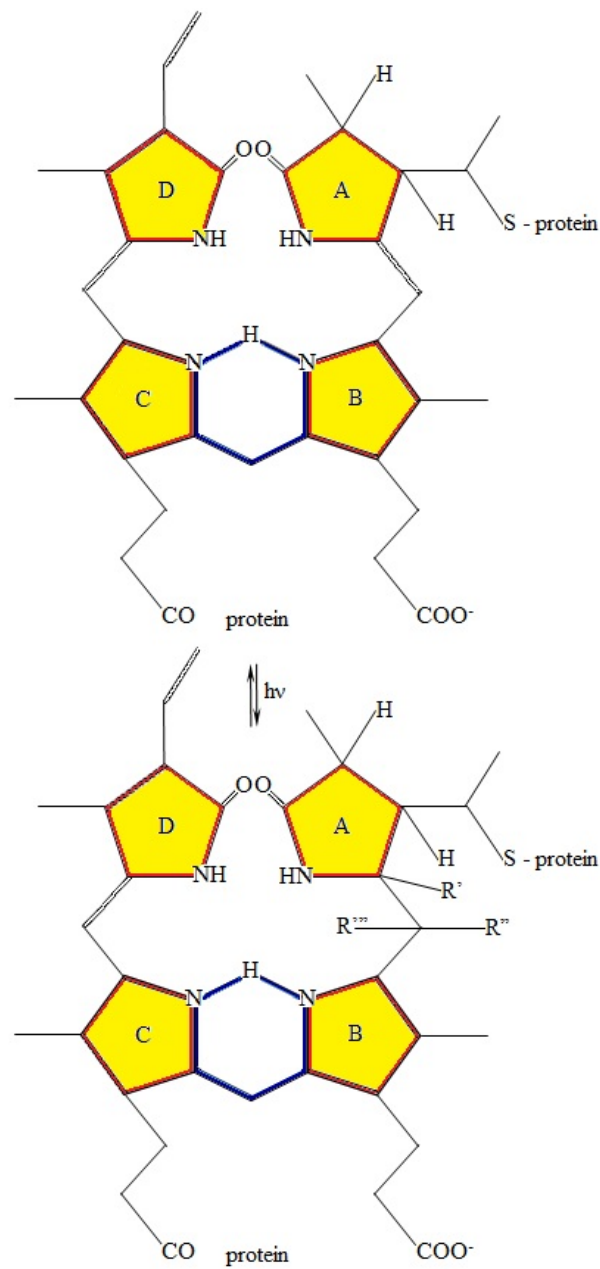

Fig. 1. Structural formula for chromophore P.

More precisely, in the case of leaves consisting of six pentagons, with help of the urn model of Gaveau and Schulmann [5] (cf. also [4]) it is possible to calculate the probability of the occurrence of the transformation (1) for definite  $(\xi, \eta)$ . For our calculations we take  $\xi = 22, \eta = 16$ ,

$$c \equiv 11 \frac{\eta}{\xi} - 7 = 0. \tag{2}$$

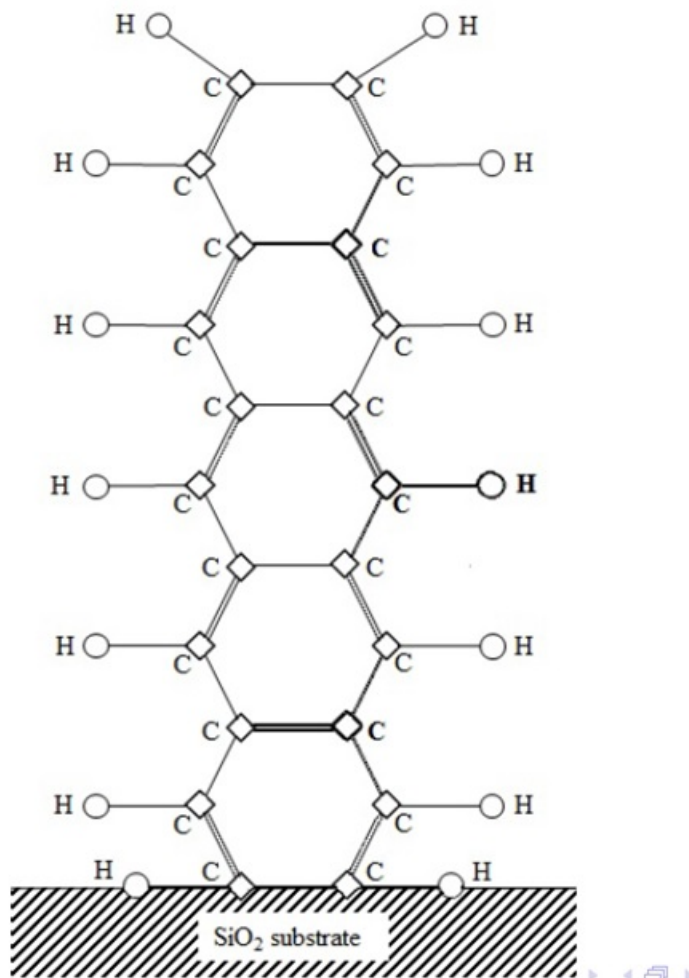

Fig. 2. The pentacene molecule  $C_{22}H_{14}$  in the usual form.

### 3. Decomposition of a quinary structure to binary structures

The carbon atom C has four 3-hands of electrons whereas the hydrogen atom H has one hand. Therefore the corresponding binary extension leading to a polymer may be proposed as shown in Fig. 7 (cf. [13]).

### 4. Decomposition of a senary structure to ternary structures

In analogy to the previous Section the corresponding ternary extension leading to a polymer may be proposed as shown in Fig. 8.

It is possible (cf. Section 1) to have polymer involving both pentagons and hexagons, for instance five pentagons and one hexagon with carbon atoms in the edges. At the moment we are leaving aside the question of composing it from the binaries only or the ternaries only (cf. [8, 9]).

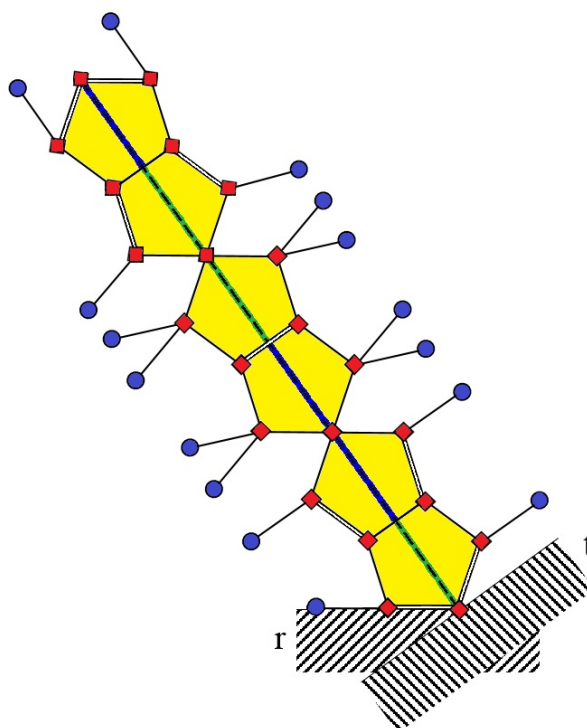

Fig. 3. A candidate for the pentacene molecule  $C_{22}H_{16}$  in the form of six pentagons (c.f. the next Section).

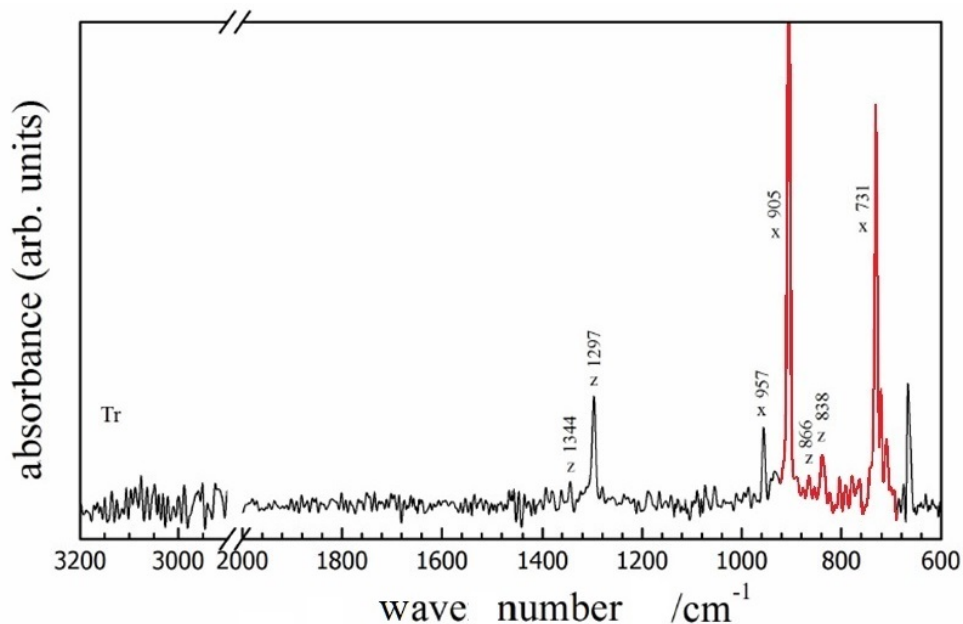

Fig. 4. The total energy (absorbance) maxima.

### 5. Slightly wavy behaviour of the system of hexagons in a pentacene leaf

The distance between the usual pentacene  $C_{22}H_{14}$  leaves (having five carbon-atomic hexagons) amount ca. at  $d \approx 1.6$  nm. It appears that the leaves of pentacene are not

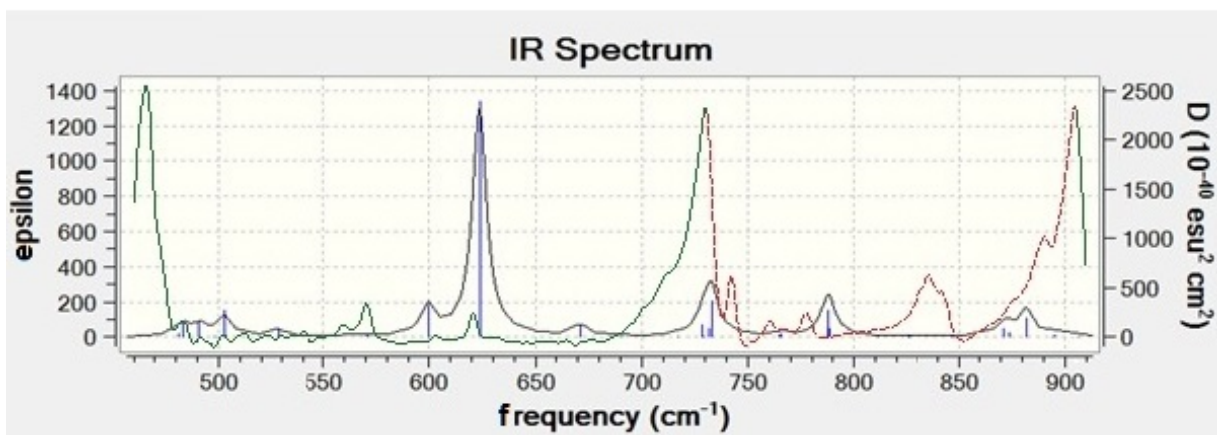

Fig. 5. Infrared activity spectrum.

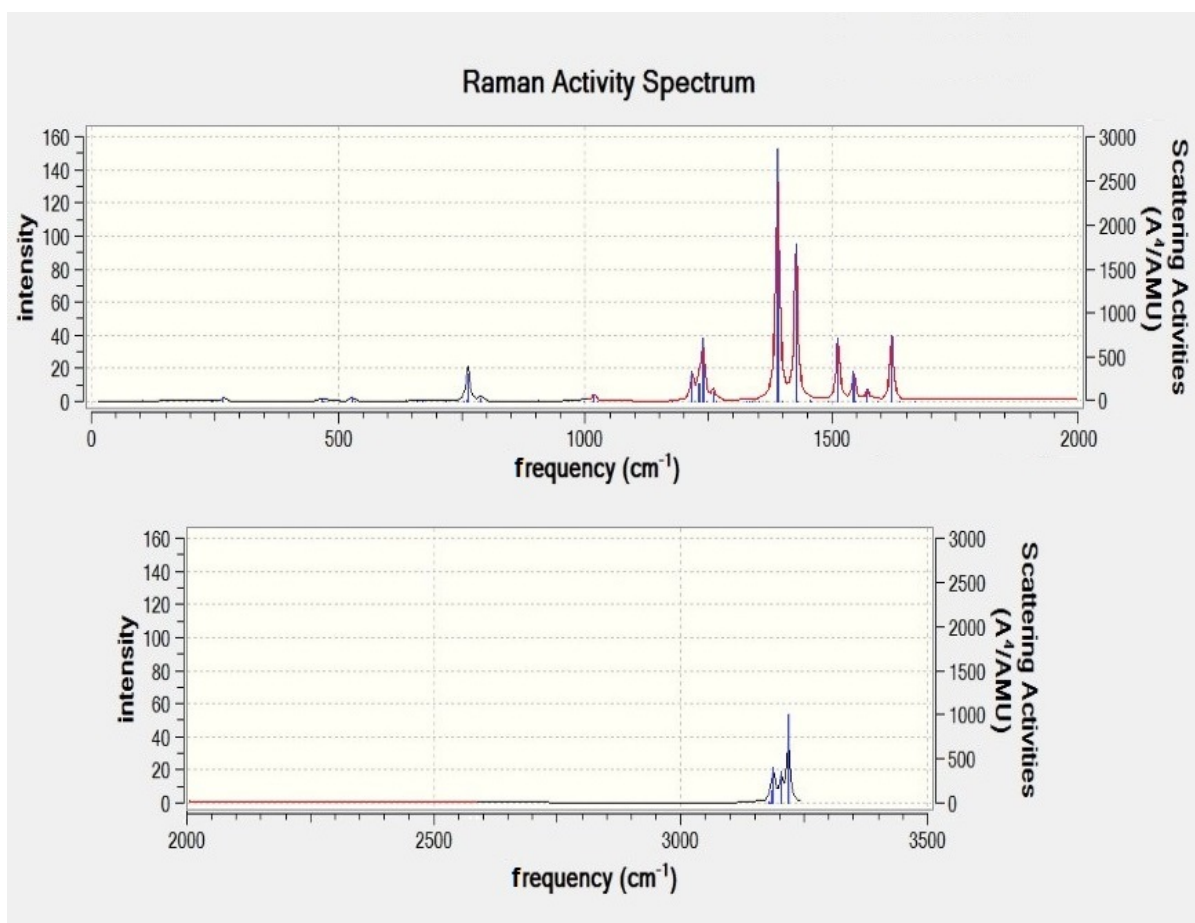

Fig. 6. Raman activity spectrum.

precisely co-planar; they meet optimal global energetic conditions when they have a slightly wavy behaviour:

**Theorem 1.** *A section of the pentacene  $C_{22}H_{14}$  orthogonal to the silicone  $SiO_2$*

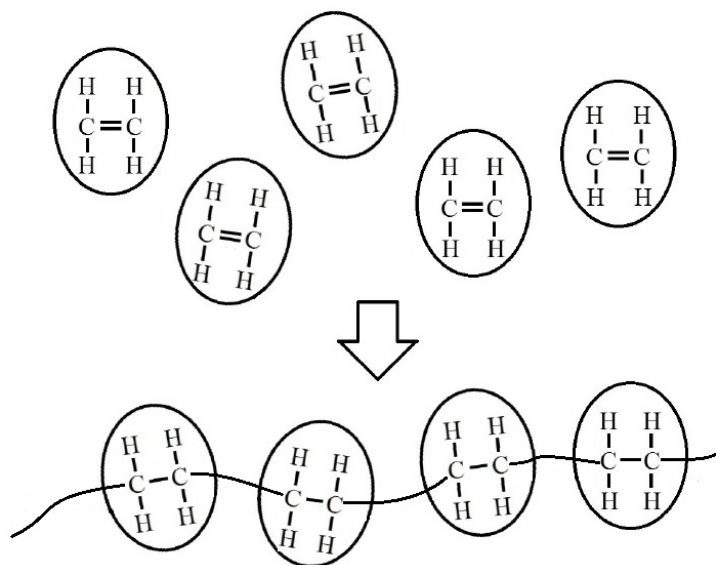

Fig. 7. The binary extension type leading to a polymer related to C and H.

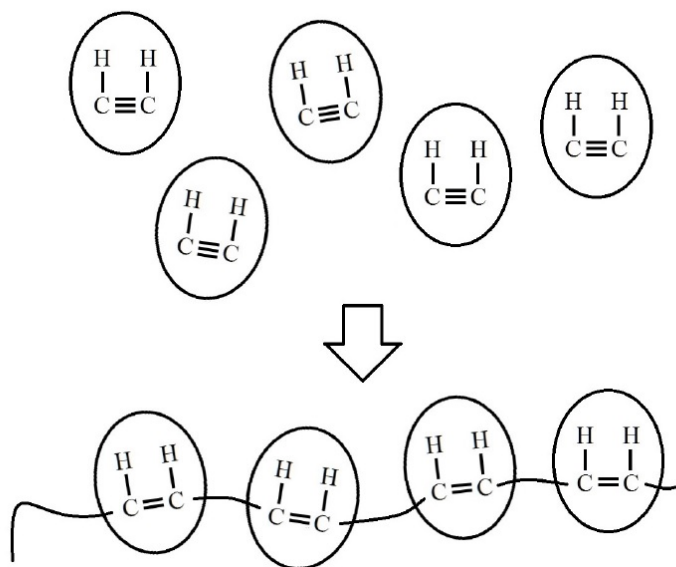

Fig. 8. The ternary extension type leading to a polymer related to C and H.

substrate is a sine-like soliton curve with maxima at  $\delta \in (0.013 \text{ nm}; 0.014 \text{ nm})$  (cf. Figs 2, 8, 9).

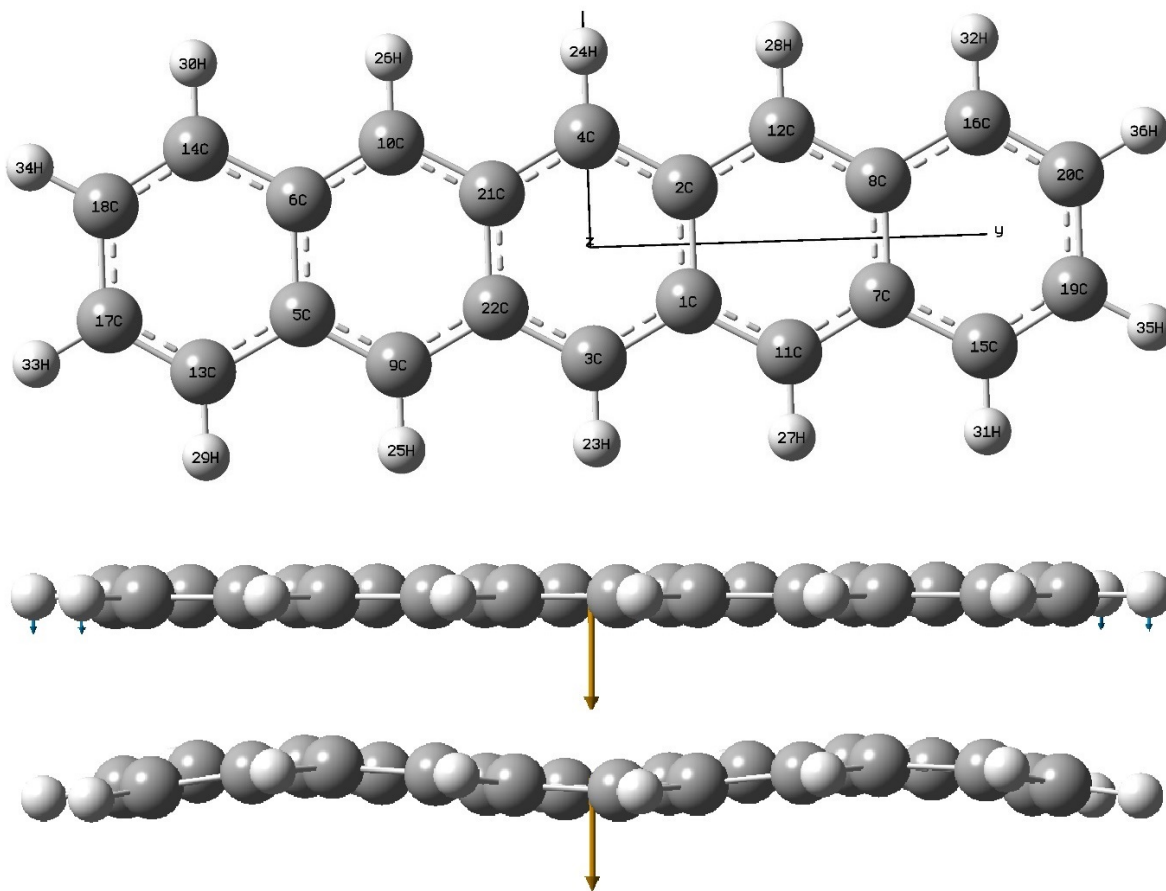

Fig. 9. The pentacene  $C_{22}H_{14}$  molecule leaf with the sine-like soliton sections.

## 6. Zigzag or meander soliton behaviour of a twisted structure of pentagons in a pentacene leaf. The sine-like case

In this case again, the distance between the consecutive leaves of the modified pentacene (leaves being six carbon-atomic pentagons)  $C_{\xi}H_{\eta}$ , in our case  $C_{22}H_{16}$  (Figs 3 and 9) amounts at  $d=1.6$  nm. We suppose that the leaves of pentacene are far from being co-planar; they meet optimal energetic conditions when they form solitary zigzags and meanders.

If we concentrate on the sine-like case (Figs 11 and 12) we get:

**Theorem 2.** A section of the pentacene  $C_{22}H_{16}$  leaf orthogonal to the silicone  $SiO_2$  substrate, in the sine-like case is a sine-like soliton curve with maxima at  $h \in (0.139$  nm,  $0.140$  nm) (cf. Figs 3, 9, 10, 11, and 12).



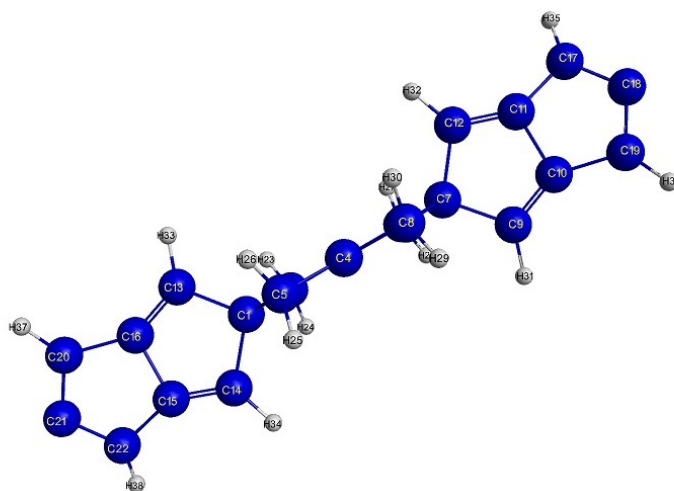

Fig. 10. Some candidate  $C_{22}H_{16}$  for a pentacene molecule in the form of six pentagons. A twisted sine-like soliton structure.

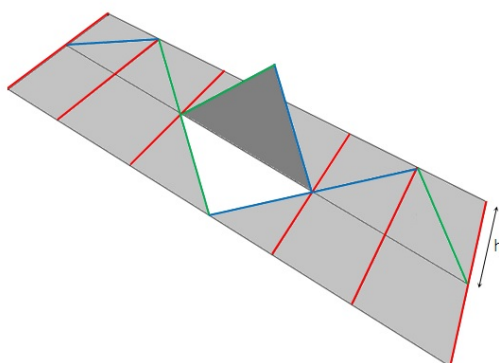

Fig. 11. The pentacene molecule structure in the form of six pentagons. Form in the sine case. The right screw-twisted structure.

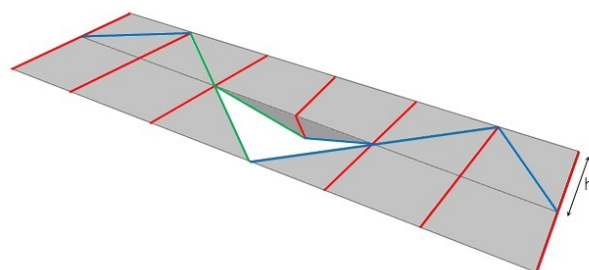

Fig. 12. The pentacene molecule structure, the left cosine twisted case.

## 7. Zigzag or meander soliton behaviour of a twisted structure of pentagons in a pentacene leaf. The cosine-like case

In this case again, the distance between the consecutive leaves of the modified pentacene (leaves being carbon atomic pentagons)  $C_\xi H_\eta$ , in our case  $C_{22}H_{16}$  (Figs 3 and 10) amounts at  $d \approx 1.6$  nm. It appears that the leaves on the pentacene are far from being co-planar: they have optimal global energetic conditions having the form of soliton zigzags or meanders. We are concentrated on the cosine-like case (Figs 14 and 15) and arrive at:

**Theorem 3.** *A section of the pentacene  $C_{22}H_{16}$  leaf orthogonal to the silicone  $SiO_2$  substrate, in the cosine-like case is a cosine-like soliton curve with maxima at  $h \in (0.139$  nm,  $0.140$  nm) (cf. Figs 3, 11, 14 and 15).*

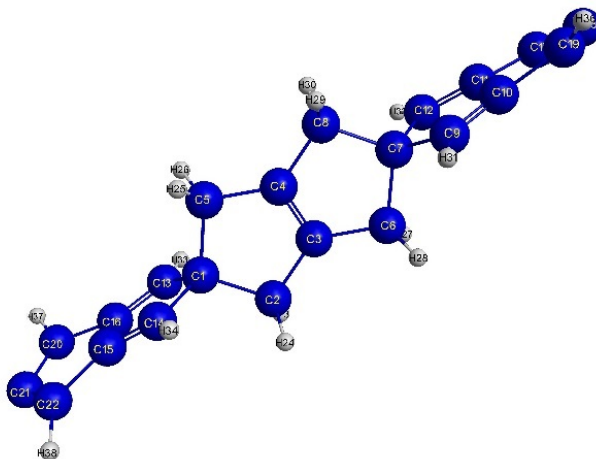

Fig. 13. Some candidate  $C_{22}H_{16}$  for a pentacene molecule in the form of six pentagons. Another twisted cosine-like structure.

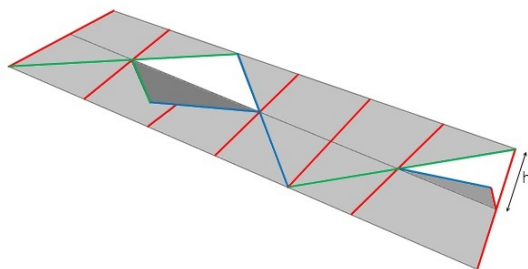

Fig. 14. The pentacene structure in the right-cosine twisted case.

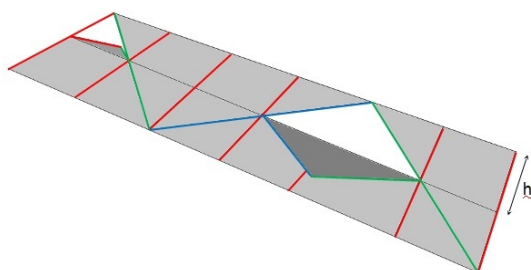

Fig. 15. The pentacene structure in the left-cosine twisted case.

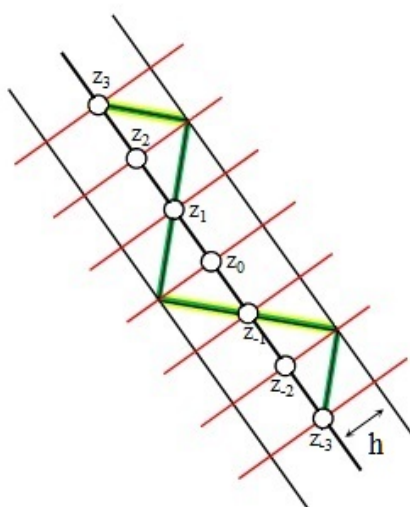

Fig. 16. A section of the pentacene  $C_{22}H_{16}$  leaf orthogonal to the silicone  $SiO_2$  substrate, in the sine-like twisted case.

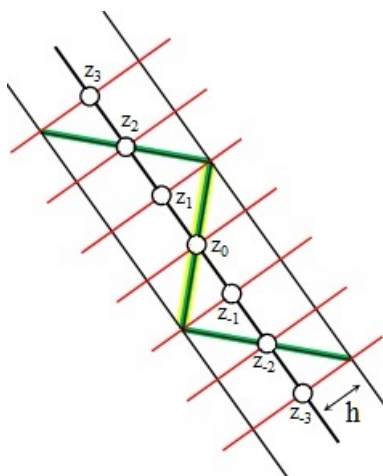

Fig. 17. A section of the pentacene  $C_{22}H_{16}$  leaf orthogonal to the silicone  $SiO_2$  substrate, in the cosine-like twisted case.

## 8. Conclusions. Pentacene as a foliated manifold with a soliton behaviour of leaves

Summing up we may consider pentacene, both in the form  $C_{22}H_{14}$  and  $C_{22}H_{16}$  as a foliated manifold with a soliton behaviour. In the senary case the system is quite close to a system of parallel planes because of considerable difference between distance  $d \approx 1.6\text{nm}$  and the maximal deviation  $\delta = 0.013\text{nm}$  of surfaces forming the system of leaves.

The whole configuration may have several mathematical and physical properties worth further investigation.

### Acknowledgements

The authors thank Professor Leszek Wojtczak and Doctor Ewelina Z. Frątczak for stimulating and helpful discussion. Presented results have been obtained by using computation performer of the Łódź University of Technology, the academic research licence of Gaussian 89 Software [15].

### References

- [1] C. Branden and J. Tooze, *Introduction to Protein Structure*, Garland Publishing, New York-London 1991.
- [2] T. E. Creighton, *Proteins: Structures and Molecular Principles*, W. H. Freeman and Co., New York 1983.
- [3] E. Z. Frątczak, J. Ławrynowicz, M. Nowak-Kępczyk, H. Polatoglou, and L. Wojtczak, *A theorem on generalized nonions and their properties for the applied structures in physics*, *Lobachevskii J. Math.*, *Lobachevskii J. of Math.*, Vol. 38, No. 2 (2017), 255261.
- [4] B. Gaveau, J. Ławrynowicz, and L. Wojtczak, *Solitons in biological membranes*, *Open Syst. Inf. Dyn.* **2** (1994), 287–293.
- [5] B. Gaveau, L. S. Schulman, *Dynamical metastability*, *J. Phys. A: Mat. Gen.* **20** (1987), 2865–2873.
- [6] Ch. Ghelis and J. L. Yon. *Protein Folding*, Academic Press, New York-London 1982.
- [7] J. Ławrynowicz, M. Nowak-Kępczyk, and O. Suzuki, *Fractals and chaos related to Ising-Onsager-Zhang lattices vs. the Jordan-von Neumann-Wigner procedures. Quaternary approach*, *Internat. J. of Bifurcations and Chaos* **22**, no. 1 (2012), 1230003 (19 pages).
- [8] J. Ławrynowicz, O. Suzuki, and A. Niemczynowicz, *On the ternary approach to Clifford structures and Ising lattices*, *Advances Appl. Clifford Algebras* **22**, no. 3 (2012), 757–769.
- [9] J. Ławrynowicz, O. Suzuki, and A. Niemczynowicz, *Fractals and chaos related to Ising-Onsager-Zhang lattices vs. the Jordan-von Neumann-Wigner procedures*.

*Ternary Approach*, Internat. J. of Nonlinear Sci. and Numer. Simul. 14, no. **34** (2013), 211–215.

- [10] Y. Nosoch and T. Sekiguchi, Protein Stability and Stabilization Through Protein Engineering, Ellis Harwood, New York-London-Toronto-Sydney-Singapore 1991.
- [11] J. -P. Sauvage, Sir J. Fraser Stoddart, and B. L. Feringa, *Nobel Prize Lecture in Chemistry 2016*, Swedish Academy of Sciences, Stockholm 2016, 12pp.
- [12] O. Suzuki, *Binary and ternary structures in physics I. The hierarchy structure of Turing machine in physics*, Bull. Soc. Sci. Lettres Łódź Sér. Rech. Déform. **66** no. 2, (2016) 45–60.
- [13] O. Suzuki, A. Niemczynowicz, and J. Ławrynowicz, *Binary and ternary structures in physics II. Binary and ternary structures in elementary particle physics vs. those in the physics of condensed matter*, Bull. Soc. Sci. Lettres Łódź Sér. Rech. Déform. **66** no. 3, (2016) 115–131.
- [14] D. J. Thouless, F. D. M. Haldane, and J. M. Kosterlitz, Nobel prize lecture in physics, Stockholm 2016, 12 pp. (F. D. M. Haldane *Nobel Lecture: Topological Quantum Matter*. Nobelprize.org. Nobel Media AB 2016. Web. 22 Jan 2017. [http://www.nobelprize.org/nobel\\_prizes/physics/laureates/2016/haldane-lecture.html](http://www.nobelprize.org/nobel_prizes/physics/laureates/2016/haldane-lecture.html); J. M. Kosterlitz, *Nobel Lecture: Topological Defects and Phase Transitions*. Nobelprize.org. Nobel Media AB 2016. Web. 22 Jan 2017. [http://www.nobelprize.org/nobel\\_prizes/physics/laureates/2016/koster-litz-lecture.html](http://www.nobelprize.org/nobel_prizes/physics/laureates/2016/koster-litz-lecture.html)
- [15] GAUSSIAN, Software Gaussian 89, Gaussian Inc., 340 Quinnipiac Street, Building 48, Wallingford, CT 06492 USA.

Osamu Suzuki  
Department of Computer and System Analysis  
College of Humanities and Sciences, Nihon University  
Sakurajosui 3-25-40, Setagaya-ku, 156-8550 Tokyo  
Japan  
E-mail: osuzuki1944butterfly@gmail.com

Julian Ławrynowicz  
Department of Solid State Physics  
University of Łódź  
Pomorska 149/153, PL-90-236 Łódź;

Institute of Mathematics Polish Academy of Sciences  
Śniadeckich 8, P.O. Box 21, PL-00-956 Warszawa  
Poland  
E-mail: jlawryno@uni.lodz.pl

Małgorzata Nowak-Kępczyk  
Institute of Mathematics and Computer Science  
The John Paul II Catholic University of Lublin  
Al. Raławickie 14, P.O. Box 129, PL-20-950 Lublin  
Poland  
E-mail: gosianmk@wp.pl

Mariusz Zubert  
Department of Microelectronics and Computer Sciences  
Łódź University of Technology  
Wólczajska 221/223, PL-90-924 Łódź  
Poland  
E-mail: mariuszz@dmcs.pl

Presented by Julian Ławrynowicz at the Session of the Mathematical-Physical Commission of the Łódź Society of Sciences and Arts on May 14, 2016.

## **GEOMETRYCZNE ASPEKTY BINARNYCH, TERNARNYCH, KWATERNARNYCH I SENARNYCH STRUKTUR W FIZYCE**

### **S t r e s z c z e n i e**

Obserwujemy, że struktury kwinarne i senarne, zarówno w przypadku pentacenu, jak i innych polimerów, można utworzyć ze struktur binarnych i senarnych w sensie równań różniczkowych i opisu geometrycznego. Liście pentacenu umieszczone na silikonowym podłożu mają postać pięciu połączonych węglowo-wodorowych sześciokątów; w całości nie tworzą dokładnie struktury planarnej lecz lekko falującą, która minimalizuje energię całkowitą. W przypadku struktury kwinarnej liście tworzą odosobnione, niemal periodyczne zygzaki i meandry.

*Słowa kluczowe:* algebry skończenie wymiarowe, pierścienie i algebry łączne, binarne struktury fizyczne, ternarne struktury fizyczne, kwinarne struktury fizyczne, senarne struktury fizyczne, pentaceni, polimer